

Schema Release Notes
AseXML Schema Working Group
Release r20

Document History

Version	Date	Authors	Comments
1.0	12/09/2006	Richard Wallbrink	Initial draft
1.1	18/09/2006	Richard Wallbrink	Added new sections as per ASWG comments

Contents

Schema Release Notes.....	1
AseXML Schema Working Group.....	1
Release r20.....	1
Document History.....	2
Contents.....	3
1. Introduction.....	3
2. Change Requests.....	3
3. Schema Manifest.....	3
4. Impact Summary.....	3
5. File Change Summary.....	3
5.1. Acknowledgements.....	3
5.2. aseXML.....	3
5.3. BAR.....	3
5.4. BulkDataTool.....	3
5.5. CATSReport.....	3
5.6. CATSTableReplication.....	3
5.7. ClientInformation.....	3
5.8. Common.....	3
5.9. CustomerDetails.....	3
5.10. CustomerTransfer.....	3
5.11. Electricity.....	3
5.12. Enumerations.....	3
5.13. Events.....	3
5.14. Faults.....	3
5.15. Gas.....	3
5.16. GasMarketWholesale.....	3
5.17. Header.....	3
5.18. MarketWholesale.....	3
5.19. MDMTReport.....	3
5.20. MeterDataManagement.....	3
5.21. NetworkBilling.....	3
5.22. NMIDataAccess.....	3
5.23. NOSAssessment.....	3
5.24. NOSBooking.....	3
5.25. NOSCommon.....	3
5.26. NOSEquipment.....	3
5.27. Reports.....	3
5.28. ServiceOrder.....	3
5.29. TableReplication.....	3
5.30. Transactions.....	3
6. Conformance Report.....	3
7. ASWG Endorsement.....	3
8. NEMMCO Approval.....	3
9. Disclaimer.....	3

1. Introduction

Version r20 of the aseXML schema has been developed from r19. The r20 version was created to:

- Provide for enhancements relating to the automation interfaces for the VicGas Wholesale Gas Market system of VENCORP
- Provide a bug fix for the MSATS schema

This document identifies the changes made to the schema for this release.

2. Change Requests

The following ASWG Change Requests have been included in this schema release:

CR#	Description
28	Incorporation VicGas Wholesale Market Transactions (Web Exchanger)
29	MSATS schema documentation and bug fix

3. Schema Manifest

The table below shows the schema files included in this release. Files that have been added, removed or modified for this release are marked.

File names	Added	Removed	Modified
Acknowledgements_r15.xsd			
aseXML_r20.xsd			X
BAR_r15.xsd			
BulkDataTool_r15.xsd			
CATSReports_r20.xsd			X
CATSTableReplication_r20.xsd			X
ClientInformation_r15.xsd			
Common_r19.xsd			
CustomerDetails_r19.xsd			
CustomerTransfer_r20.xsd			X
Electricity_r19.xsd			
Enumerations.xsd			
Events_r20.xsd			X
Faults_r15.xsd			
Gas_r19.xsd			
GasMarketWholesale_r20.xsd	X		
Header_r20.xsd			
MarketWholesale_r20.xsd	X		
MDMTRReport_r15.xsd			
MeterDataManagement_r19.xsd			
NetworkBilling_r15.xsd			
NMIDataAccess_r17.xsd			
NOSAssessment_r18.xsd			
NOSBooking_r18.xsd			
NOSCommon_r18.xsd			
NOSEquipment_r18.xsd			
Reports_r15.xsd			
ServiceOrder_r17.xsd			
TableReplication_r15.xsd			
Transactions_r20.xsd			X
No of files added	2		
No of files removed		0	
No of files modified			6
Total No of files			30

4. Impact Summary

This table identifies the files, transactions and versioned types that are potentially impacted as the result of this schema where:

- Modified types - is a full list of types changed in this schema
- Derived types – is a list of any types that are derived from a modified type, and are therefore also modified by default
- Versioned types affected – is a list of all versioned types have had the version attribute updated as a result of this schema
- Transactions potentially affected – is a list of all transactions that contain a modified type, either directly or via a type substitution
- Schema files affected – is a list of schema files that have been changed in some way from the last version of the schema to this one.

Modified types	Derived types	Versioned types affected	Transactions potentially affected	Schema files affected
DataRangeReportParameters changed to DateRangeReportParameters		Changed to r20	Report Response	CATS_Reports.xsd
Transaction	-	-	-	Transactions_r20.xsd
TransactionGroup	-	-	-	Header_r20.xsd
New types for additional Gas Wholesale transactions		-	-	New: MarketWholesale_r20.xsd GasMarketWholesale_r20.xsd

Table 4-1, Impact Summary

5. File Change Summary

5.1. Acknowledgements

- No change.

5.2. aseXML

- Changed aseXML namespace to urn:aseXML:r20
- R20 files included: MarketWholesale_r20.xsd, GasMarketWholesale_r20.xsd

```
<xsd:schema targetNamespace="urn:aseXML:r20" >
  <xsd:include schemaLocation="Events_r19.xsdEvents_r20.xsd" >
</xsd:include>
  <xsd:include schemaLocation="CustomerTransfer_r19.xsdCustomerTransfer_r20.xsd" >
</xsd:include>
  <xsd:include schemaLocation="Header_r15.xsdHeader_r20.xsd"/>
  <xsd:include schemaLocation="MarketWholesale_r20.xsd" >
  <xsd:annotation>
  <xsd:documentation>
    Purpose - Include data types for common market wholesale functionality.
  </xsd:documentation>
  </xsd:annotation>
</xsd:include>
  <xsd:include schemaLocation="GasMarketWholesale_r20.xsd" >
  <xsd:annotation>
  <xsd:documentation>
    Purpose - Include data types for gas market wholesale functionality.
  </xsd:documentation>
  </xsd:annotation>
</xsd:include>
  <xsd:include schemaLocation="Transactions_r19.xsdTransactions_r20.xsd"/>
  <xsd:include schemaLocation="CATSTableReplication_r19.xsdCATSTableReplication_r20.xsd"/>
  <xsd:include schemaLocation="CATSReports_r19.xsdCATSReports_r20.xsd"/>
</xsd:schema>1
```

5.3. BAR

- No change.

5.4. BulkDataTool

- No change.

5.5. CATSReport

- DataRangeReportParameters replaced with DateRangeReportParameters
- Schema differences

```
<xsd:complexType name="DateRangeReportParameters" ... >
  <xsd:annotation ... >
    <xsd:documentation> Purpose - Parameters for a CATS Security Report Report Name - C8
  </xsd:documentation>
  </xsd:annotation>
  <xsd:complexContent>
```

¹ Data that has been modified is shown *like this*. Data that has been deleted is shown ~~like this~~. Data that is added is shown *like this*

```

    <xsd:extension base="BaseReportParameters">
      <xsd:sequence>
        <xsd:element name="FromDate" type="xsd:dateTime"/>
        <xsd:element name="ToDate" type="xsd:dateTime"/>
      </xsd:sequence>
      <xsd:attribute name="version" type="r20"/>
    </xsd:extension>
  </xsd:complexContent>
</xsd:complexType>

```

5.6. CATSTableReplication

- Documentation for the following types corrected: MSATSCodeValueType, MSATSCodeValue, MSATSCodeValueDescription, MSATSCodeValuesRow.
- Schema differences

```

<xsd:simpleType name="MSATSCodeValueType">
  <xsd:annotation>
    <xsd:documentation> MSATS Data Model Column - ObjRuleDesc MSATS Data Model Column - CodeType
  </xsd:documentation>
</xsd:annotation>
</xsd:simpleType>
<xsd:simpleType name="MSATSCodeValue">
  <xsd:annotation>
    <xsd:documentation> MSATS Data Model Column - ObjRuleDesc MSATS Data Model Column - CodeValue
  </xsd:documentation>
</xsd:annotation>
</xsd:simpleType>
<xsd:simpleType name="MSATSCodeValueDescription">
  <xsd:annotation>
    <xsd:documentation> MSATS Data Model Column - ObjRuleDesc MSATS Data Model Column - CodeValueDesc
  </xsd:documentation>
</xsd:annotation>
</xsd:simpleType>

<xsd:complexType name="MSATSCodeValuesRow">
  <xsd:annotation>
    <xsd:documentation> Purpose - Row of the CATSChangeStatusCodes table MSATS Data Model Table - CATS_CR_Status_Codes Replication Table Name - CATSChangeStatusCodes Purpose - Row of the MSATSCodeValues table MSATS Data Model Table - MSATS CODE VALUES Replication Table Name - MSATSCodeValues
  </xsd:documentation>
</xsd:annotation>
</xsd:complexType>

```

5.7. ClientInformation

- No change.

5.8. Common

- No change.

5.9. CustomerDetails

- No Change

5.10. CustomerTransfer

- The following elements of the CATSNotification transaction are documented:

- JurisdictionCode: "This is the what the jurisdiction code would be after after CR completes (if the jurisdiction code is being changed in the CR)"
- NMIClassificationCode: "This is the what the NMI Classification code would be after after CR completes (if the NMI Classification code is being changed in the CR)"
- NMIStatus: "Will be populated only in notifications of CRs which are for transfer of de-energised NMIs. This would be the current value of the NMI Classification code. It could be different than what the NMI Classification code would be after CR completes (if the NMI Classification code is also being changed in the CR - which currently is not allowed in tranfer CRs)"

- Schema differences

```
<xsd:complexType name="CATSNotification">
```

```
- <xsd:sequence>
```

```
- <xsd:element name="Role" type="RoleIdentifier">
```

```
- <xsd:element type="JurisdictionCode" name="JurisdictionCode" minOccurs="0">
```

```
- <xsd:annotation>
```

```
- <xsd:documentation> This is what the Jurisdiction code would be after CR completes (if the jurisdiction code is being changed in the CR)</xsd:documentation>
```

```
</xsd:annotation>
```

```
</xsd:element>
```

```
- <xsd:element type="NMIClassificationCode" minOccurs="0" name="NMIClassificationCode">
```

```
- <xsd:annotation>
```

```
- <xsd:documentation> This is what the NMI Classification code would be after CR completes (if the NMI Classification code is being changed in the CR)</xsd:documentation>
```

```
</xsd:annotation>
```

```
</xsd:element>
```

```
- <xsd:element name="NMIStatus" type="NMIStatusCode" minOccurs="0">
```

```
- <xsd:annotation>
```

```
- <xsd:documentation> Will be populated only in notifications of CRs which are for transfer of de-energised NMIs. This would be the current value of the NMI Status code. It could be different than what the NMI Status code would be after CR completes (if the NMI Status code is also being changed in the CR - which currently is not allowed in transfer CRs)</xsd:documentation>
```

```
</xsd:documentation>
```

```
</xsd:annotation>
```

```
</xsd:element>
```

```
</xsd:sequence>
```

```
</xsd:complexType>
```

5.11. Electricity

- No change.

5.12. Enumerations

- No change.

5.13. Events

- R20 version type added

- Schema differences:

```
<xsd:simpleType name="r20">
```

```
<xsd:annotation>
```

```
<xsd:documentation> Purpose - Release r20 identifier</xsd:documentation>
```

```
</xsd:annotation>
```

```
<xsd:restriction base="ReleaseIdentifier">  
  <xsd:enumeration value="r20"/>  
</xsd:restriction>  
</xsd:simpleType>
```

5.14. Faults

- No change.

5.15. Gas

- No change.

5.16. GasMarketWholesale

- New file that has been added that has the addition of Complex Types, which are extension of their corresponding Wholesale Complex base types
- The new types are shown below in UML notation

GasRetrieveRequestData

GasRetrieveRequestData is an extension of the WholesaleRetrieveRequestData complex element.

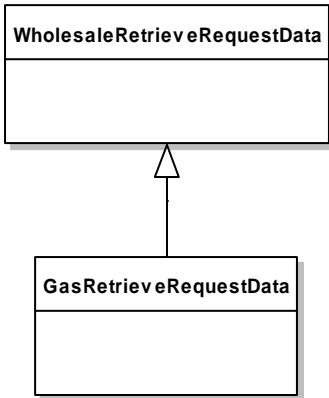

Below is a representation of the GasRetrieveRequestData complex element as required by gas wholesale market.

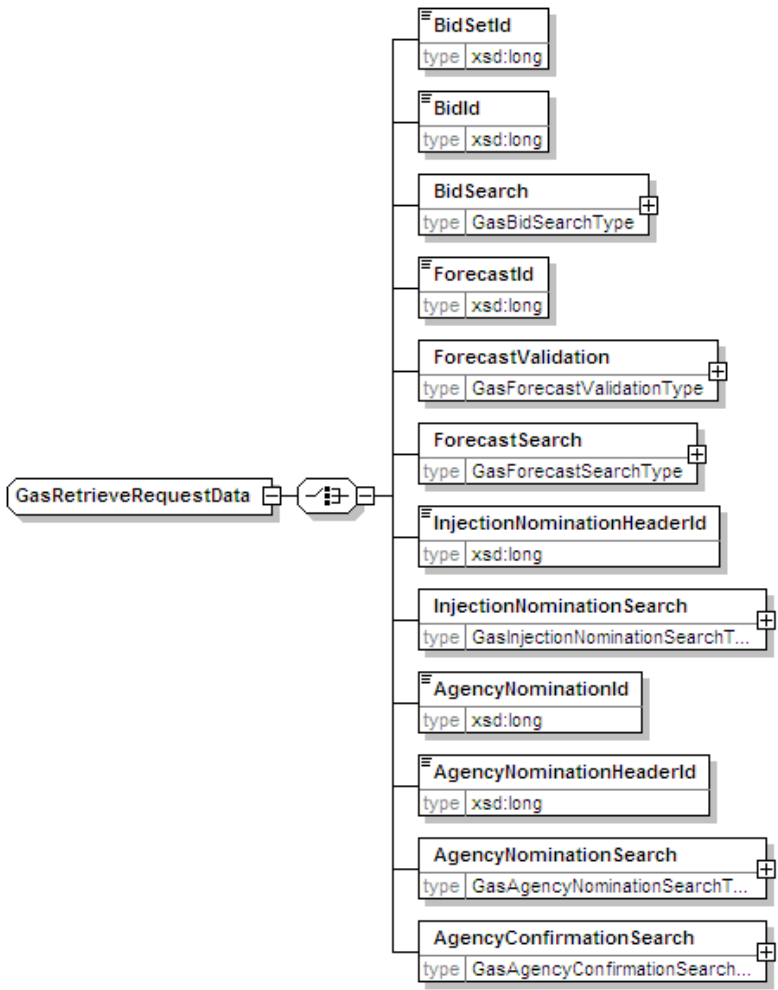

GasRetrieveResponseData

GasRetrieveResponseData is an extension of the WholesaleRetrieveResponseData complex element. It will be sent in response to GasRetrieveRequestData element.

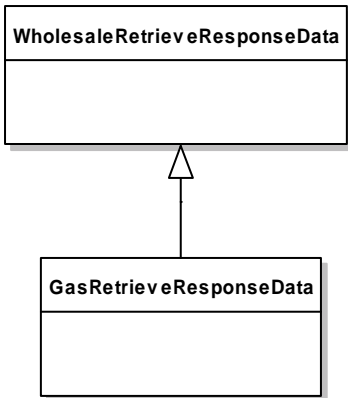

The following is a representation of the GasRetrieveResponseData element as required by the gas wholesale market.

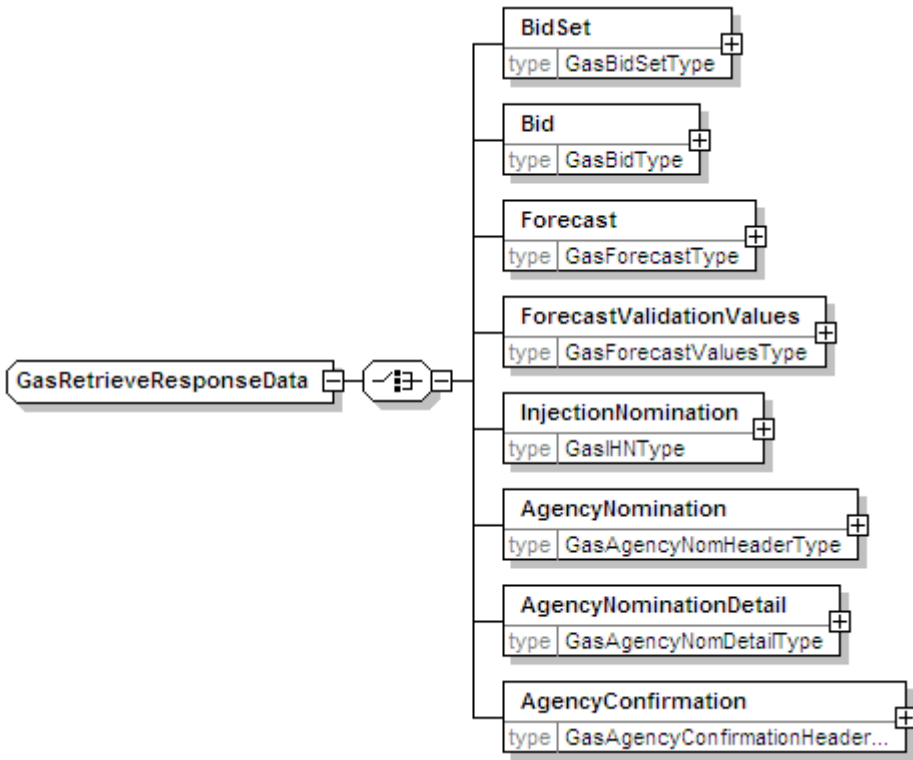

GasSearchRequestData

GasSearchRequestData is an extension of the WholesaleSearchRequestData complex element.

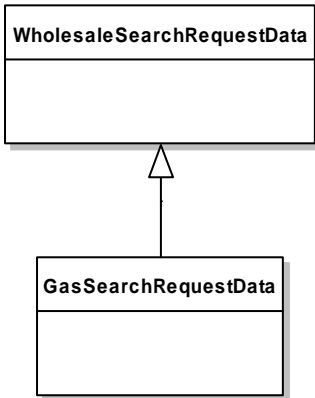

The following is a representation of the GasSearchRequestData element as required by the gas wholesale market.

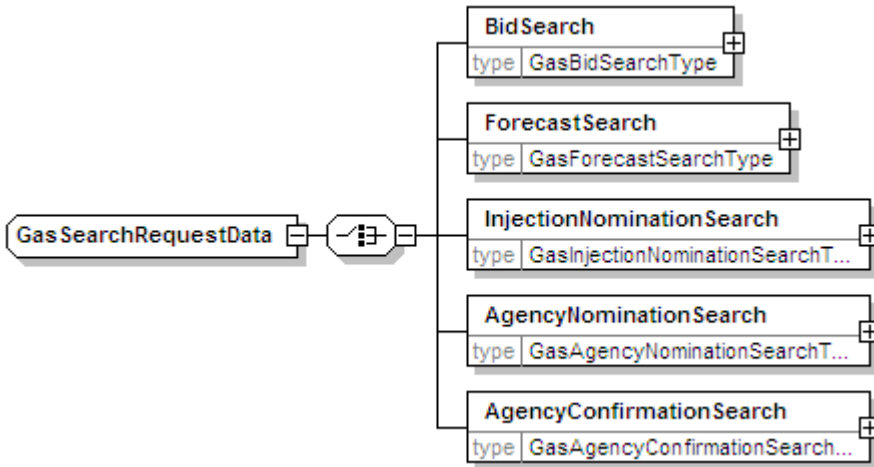

GasSearchResponseData

The GasSearchResponseData is an extension of the WholesaleSearchResponseData complex element. It will be generated in response to the web service request containing GasSearchRequestData complex element.

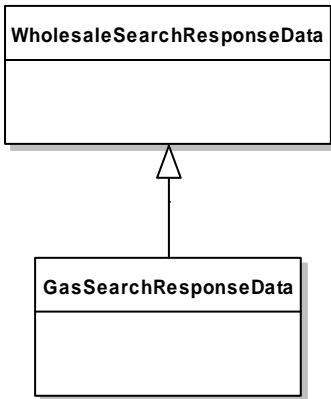

The following is a representation of the GasSearchResponseData complex element as required by wholesale gas market.

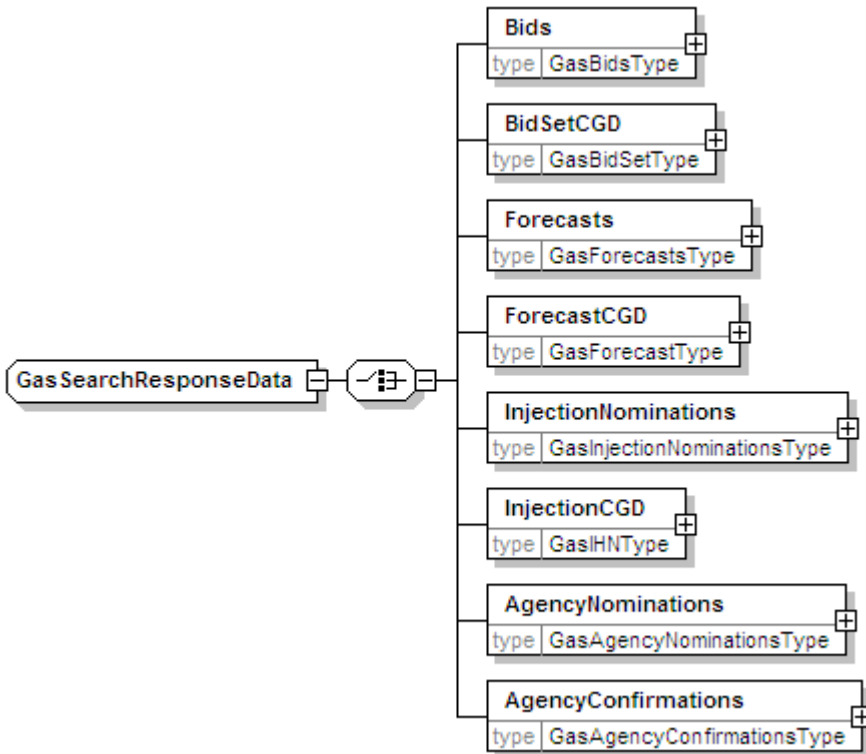

GasSubmitRequestData

The GasSubmitRequestData is a complex type extending the WholesaleSubmitRequestData complex element.

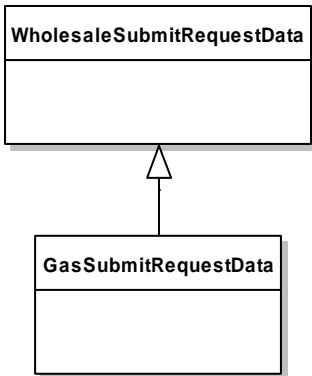

The following is a representation of the GasSubmitRequestData complex element as required by the wholesale gas market.

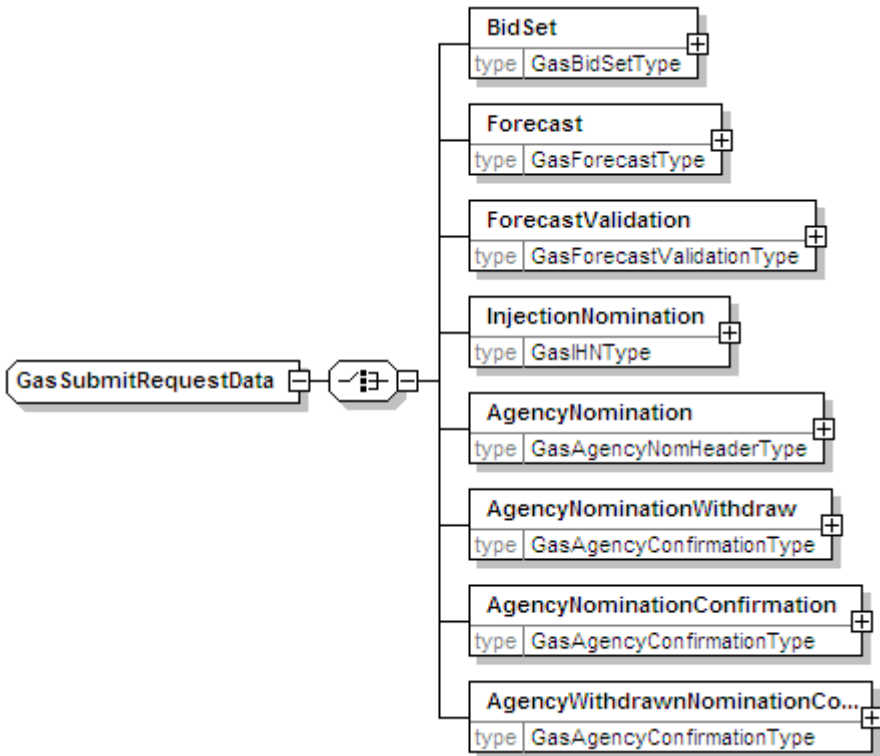

GasSubmitResponseData

The GasSubmitResponseData complex type is an extension of the WholesaleSubmitResponseData complex type. It will be generated in response to GasSubmitRequestData element.

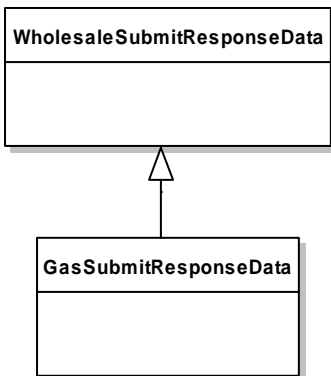

The following is a representation of the GasSubmitResponseData complex type as required by wholesale gas market.

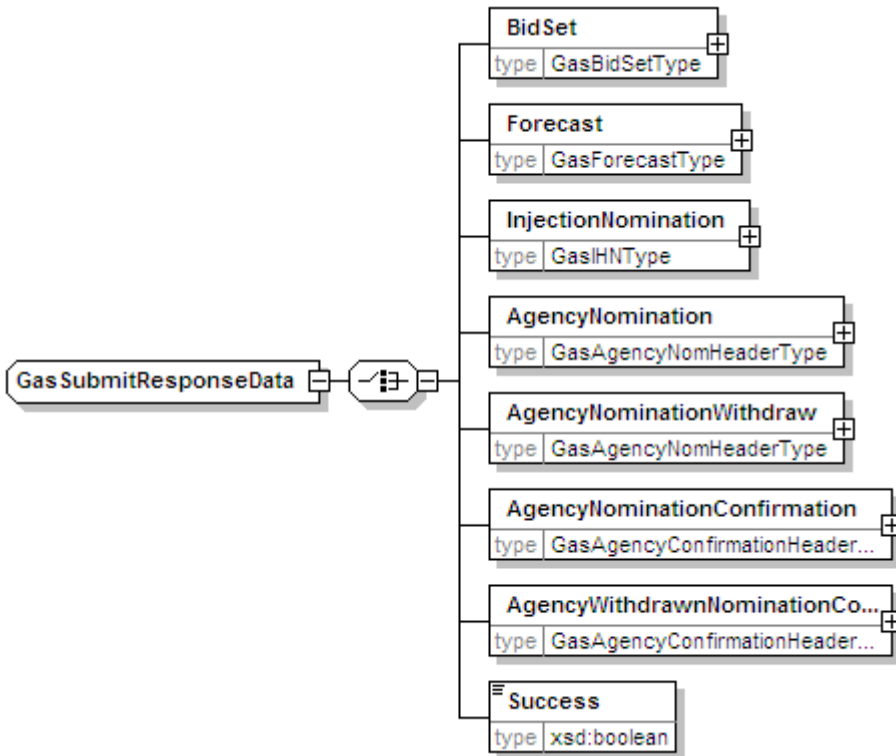

GasInformationRequestData

The GasInformationRequestData is an extension of the WholesaleInformationRequestData complex type.

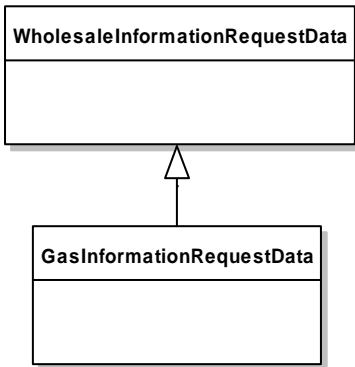

The following is a representation of the GasInformationRequestData as required by whole gas market.

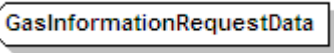

GasInformationResponseData

The GasInformationResponseData is an extension of the WholesaleInformationResponseData complex type. It will be generated in response to GasInformationRequestData.

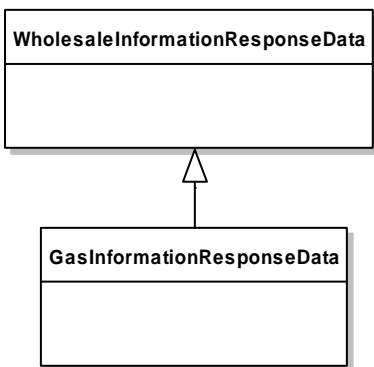

The following is a representation of the GasInformationResponseData complex type as required by wholesale gas market.

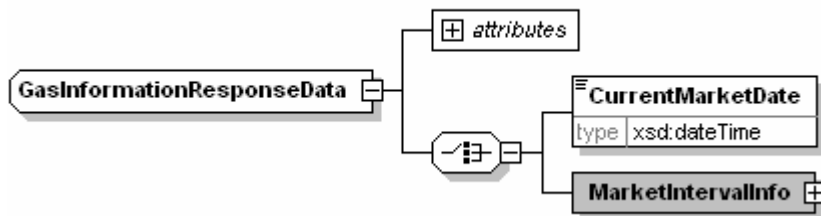

5.17. Header

- Added new transaction group of MKTW - Wholesale market operations
- Schema differences.

```

<xsd:simpleType name="TransactionGroup">
  <xsd:annotation>
    <xsd:documentation>
      MKTW - Wholesale market operations
    </xsd:documentation>
  </xsd:annotation>
</xsd:simpleType>
    
```

```

        </xsd:annotation>
        <xsd:restriction base="xsd:string">
            <xsd:enumeration value="MKTW"/>
        </xsd:restriction>
    </xsd:simpleType>

```

5.18. MarketWholesale

- New file that has been created that introduces base types common to both gas and electricity wholesale markets
- Schema

```

<?xml version="1.0" encoding="UTF-8"?>
<xsd:schema xmlns:xsd="http://www.w3.org/2001/XMLSchema">
  <!-- ===== -->
  <!-- Transaction Definitions -->
  <!-- ===== -->
  <xsd:complexType name="WholesaleRetrieveRequest">
    <xsd:sequence>
      <xsd:element name="RetrieveRequestData" type="WholesaleRetrieveRequestData"/>
    </xsd:sequence>
    <xsd:attribute name="version" type="r20" use="optional" default="r20"/>
  </xsd:complexType>
  <xsd:complexType name="WholesaleRetrieveResponse">
    <xsd:sequence>
      <xsd:element name="RetrieveResponseData" type="WholesaleRetrieveResponseData"/>
    </xsd:sequence>
    <xsd:attribute name="version" type="r20" use="optional" default="r20"/>
  </xsd:complexType>
  <xsd:complexType name="WholesaleSearchRequest">
    <xsd:sequence>
      <xsd:element name="SearchRequestData" type="WholesaleSearchRequestData"/>
    </xsd:sequence>
    <xsd:attribute name="version" type="r20" use="optional" default="r20"/>
  </xsd:complexType>
  <xsd:complexType name="WholesaleSearchResponse">
    <xsd:sequence>
      <xsd:element name="SearchResponseData" type="WholesaleSearchResponseData"/>
    </xsd:sequence>
    <xsd:attribute name="version" type="r20" use="optional" default="r20"/>
  </xsd:complexType>
  <xsd:complexType name="WholesaleSubmitRequest">
    <xsd:sequence>
      <xsd:element name="SubmitRequestData" type="WholesaleSubmitRequestData"/>
    </xsd:sequence>
    <xsd:attribute name="version" type="r20" use="optional" default="r20"/>
  </xsd:complexType>
  <xsd:complexType name="WholesaleSubmitResponse">
    <xsd:sequence>
      <xsd:element name="SubmitResponseData" type="WholesaleSubmitResponseData"/>
    </xsd:sequence>
    <xsd:attribute name="version" type="r20" use="optional" default="r20"/>
  </xsd:complexType>
  <xsd:complexType name="WholesaleInformationRequest">
    <xsd:sequence>
      <xsd:element name="InformationRequestData" type="WholesaleInformationRequestData"/>
    </xsd:sequence>
    <xsd:attribute name="version" type="r20" use="optional" default="r20"/>
  </xsd:complexType>
  <xsd:complexType name="WholesaleInformationResponse">
    <xsd:sequence>
      <xsd:element name="InformationResponseData" type="WholesaleInformationResponseData"/>
    </xsd:sequence>
    <xsd:attribute name="version" type="r20" use="optional" default="r20"/>
  </xsd:complexType>
  <!-- ===== -->
  <!-- Transaction Payload Definitions -->
  <!-- ===== -->
  <xsd:complexType name="WholesaleRetrieveRequestData" abstract="true"/>
  <xsd:complexType name="WholesaleRetrieveResponseData" abstract="true"/>
  <xsd:complexType name="WholesaleSearchRequestData" abstract="true"/>
  <xsd:complexType name="WholesaleSearchResponseData" abstract="true"/>
  <xsd:complexType name="WholesaleSubmitRequestData" abstract="true"/>
  <xsd:complexType name="WholesaleSubmitResponseData" abstract="true"/>
  <xsd:complexType name="WholesaleInformationRequestData" abstract="true"/>

```

```
<xsd:complexType name="WholesaleInformationResponseData" abstract="true" />
</xsd:schema>
```

5.19. MDMTReport

- No change.

5.20. MeterDataManagement

- No change.

5.21. NetworkBilling

- No change.

5.22. NMIDataAccess

- No change.

5.23. NOSAssessment

- No change

5.24. NOSBooking

- No change

5.25. NOSCommon

- No change

5.26. NOSEquipment

- No Change

5.27. Reports

- No change.

5.28. ServiceOrder

- No change.

5.29. TableReplication

- No change.

5.30. Transactions

- Eight new transactions added
 - WholesaleRetrieveRequest
 - WholesaleRetrieveResponse
 - WholesaleSearchRequest
 - WholesaleSearchResponse
 - WholesaleSubmitRequest
 - WholesaleSubmitResponse
 - WholesaleInformationRequest
 - WholesaleInformationResponse

6. Conformance Report

The ASWG completes the conformance report validating each new or altered schema file against the published aseXML guidelines.

Schema Filename	Impacted by CR #	Conformance Details
aseXML_r20.xsd	28,29	Conforms
Event_r20.xsd	28,29	Conforms
Header_r20.xsd	28	Conforms
Transactions_r20.xsd	28	Conforms
MarketWholesale_r20.xsd	28	Conforms
GasMarketWholesale_r20.xsd	28	Conforms
CATSReports_r20.xsd	29	Conforms
CATSTableReplication_r20.xsd	29	Conforms
CustomerTransfer_r20.xsd	29	Conforms

Table 6-1, Schema Conformance Details

7. ASWG Endorsement

The ASWG votes for endorsement of the schema, with the included aseXML Change Requests, and the voting results are forwarded to NEMMCO for approval. When 75% of those ASWG members who voted endorse a schema, this represents an ASWG Recommendation for that schema. NEMMCO will not reject an ASWG Recommendation without first consulting with the ASWG.

The results of the ASWG vote for the final schema to be released are as follows:

Date of Vote: 15/9/2006

Vote	# Votes	% Vote
For	6	85%
Against	0	0%
Abstained	1	15%
Total Members Present	7	100%

Table 7-1, ASWG Vote Results for Schema

8. NEMMCO Approval

The schema status and status date are identified below

Status	Date	Authorised by
Approved – The schema has been approved by NEMMCO and is formally released for use	19 Sept 2006	Maria Zavros – Head of Information Services

9. Disclaimer

Independent Confirmation - ASWG strongly advises that all information or material contained in this file should be independently verified before use. The user may need to inform themselves of other relevant information or business processes.

No Warranty – Neither ASWG nor any of ASWG's advisers, consultants or other contributors to this file (or their respective associated companies, businesses, partners, directors, officers or employees) make any representation or warranty, express or implied, as to the currency, accuracy, reliability or completeness of the information or material contained in, referred to in or accessed from this file.

No Liability - To the maximum extent permitted by law, neither ASWG nor any of its advisers, consultants or other contributors to this file (or their respective associated companies, businesses, partners, directors, officers or employees) shall have any liability (whether arising from negligence or otherwise) in respect of the use of the file or information contained in, referred to in or accessed from this file (including any reliance on the currency, accuracy, reliability or completeness of the information).