Schema Change Request

Document ID	28
Change Type	Enhancements
Title	Incorporation VicGas Wholesale Market Transactions (Web Exchanger)
Date	20 July 2006
Prepared By	Michael Kroumer, Andrew Screen, & Anne Waller
Priority	

Document Control

Version	Date	Author	Summary of Change
1.0	13 th June 06	Andrew Screen, Michael Kroumer & Anne Waller	Change proposal
2.0	16 Aug 06	Andrew Screen, & Michael Kroumer	Updates based upon initial Review
3.0	4 Sep 2006	Darren Field	Finalised decision regarding default version attributes on transactions.
4.0	12 September	Nada Reinprecht	Completed Approval Assessment sections
5.0	15 Sep 2006	Darren Field	Final version for release

Document Status

Contents

Schema Change Request	1
Document Control	2
Document Status.....	2
Contents.....	3
1 Change Proposal.....	3
1.1 Description of the proposed change.....	3
1.2 Web Services - Bid Service	3
1.2.1 GetBid.....	3
1.2.2 GetBidSet.....	3
1.2.3 GetBidSetForCGD.....	3
1.3 SearchBids.....	3
1.4 SubmitBid.....	3
1.5 Web Services – Demand Forecast Service	3
1.5.1 GetForecast.....	3
1.5.2 GetForecastForCGD	3
1.5.3 GetValidationValues.....	3
1.5.4 SetValidationValues	3
1.5.5 SearchForecasts	3
1.5.6 SubmitForecast	3
1.6 Web Services – Injection Hedge Nomination Service.....	3
1.6.1 GetInjectionHedgeNomination	3
1.6.2 GetInjectionHedgeNominationForCGD	3
1.6.3 SearchInjectionHedgeNominations	3
1.6.4 SubmitInjectionHedgeNomination	3
1.7 Web Services – Agency Hedge Nomination Service.....	3
1.7.1 GetAgencyNominationHeader.....	3
1.7.2 GetAgencyNominationDetail	3
1.7.3 SearchNominations.....	3
1.7.4 SubmitNomination.....	3
1.7.5 SubmitNominationWithdrawn.....	3
1.7.6 SubmitConfirmation	3
1.7.7 SearchConfirmations	3
1.7.8 SubmitWithdrawnNominationConfirmed.....	3
1.7.9 GetAgencyConfirmationHeader	3
1.8 Web Services – System Service.....	3
1.8.1 GetCurrentGasDate.....	3
1.9 Reason for Change.....	3

1.10 Baseline Schema 3

2 Approval Proposal 3

2.1 Draft Schema 3

2.2 Change log 3

2.3 Schema change description 3

2.3.1 aseXML Top Level Schema 3

2.3.2 Transactions schema 3

2.3.3 Events schema 3

2.3.4 Header schema 3

2.3.5 Market Wholesale Schema 3

2.3.6 Gas Market Wholesale Schema 3

2.4 Impact Summary 3

2.5 Developer Test 3

2.5.1 Test Platforms 3

2.5.2 Test Cases 3

3 Proposal Assessment 3

3.1 Test 3

3.1.1 Test Platforms 3

3.1.2 Test Cases 3

3.1.3 Test Results 3

3.2 Conformance Report 3

4 Issue Register 3

4.1 Status of Issues 3

5 Resolution 3

5.1 Draft Schema ASWG Vote 3

5.2 Default Transaction Versions ASWG Vote 3

5.3 Final Schema ASWG Vote 3

Tables

Table 1-1, Proposed Changes 3

Table 2-1 Change Log 3

Table 2-2, Impact Summary 3

Table 3-1, Change Proposal Conformance Details 3

Table 4-1, Issues list 3

Table 5-1, ASWG Vote Results for Draft Schema 3

Table 5-2, ASWG Vote Results for Default Transaction Versions 3

Table 5-3, ASWG Vote Results for Final Schema 3

1 Change Proposal

This Change Proposal contains the following:

- Request for enhancements relating to the automation interfaces for the VicGas Wholesale Gas Market system of VENCORP.

1.1 Description of the proposed change

The VicGas Wholesale Gas Market Automation Web Services are implemented by VENCORP, and are split up into a number of discrete services relating to particular areas of functionality:

- Bid service
- Demand forecast service
- Injection hedge nomination service
- Agency injection hedge nomination service.
- System service

The document/literal contents in the VENCORP web services are based upon the existing **aseXML specification** to be updated to include new transactions specifically defined for the new wholesale gas market and detailed in the following sections of this document. The web services XML Schema is a subset of the aseXML specification, and uses elements and types defined within the aseXML schema.

Note, in spite of batching capabilities incorporated into aseXML, the VENCORP web services will carry only a single transaction, and no batching is allowed.

The use of aseXML Header element is not required by web services. The conversation is always held by an authenticated party to VENCORP. In this scenario, the use of header is redundant. However, to ensure consistent usage, the aseXML header will always have populated all mandatory elements:

```
<Header>
  <From>Market Participant</From>
  <To>VENCORP</To>
  <MessageID>117CF3AE-EDDF-2456-02F3-C733881DA789</MessageID>
  <MessageDate>2006-06-22T11:24:59.596+10:00</MessageDate>
  <TransactionGroup>MKTW</TransactionGroup>
  <Priority>Medium</Priority>
  <Market>VICGAS</Market>
</Header>
```

Values <From> and <To> elements when generated by VENCORP will be set to “**VENCORP WebExchanger**” and the MarketParticipant’s company name respectively. VENCORP will not be validating the values provided in those fields as the web service call origin context will be already known, and the user/system had been authenticated.

The <MessageID> will be populated with a unique identifier. The <MessageDate> will have the date/time when the message has been generated by the application or the web services client. The <TransactionGroup> will always be set to MKTW. The <Priority> element will always be set to Medium. The <Market> element will be always set to VICGAS.

The proposed changes are listed in the following table.

Table 1-1, Proposed Changes

Item#	Change Description	Change Type
Business Changes		
1.	Inclusion of new Bid transactions to support the Web Services automation in the VicGas Wholesale market. Provides for the bids submission and retrieval functions. Relevant operation descriptions are provided in the section 1.2.	Enhancement

Item#	Change Description	Change Type
2.	Inclusion of new Market Participant's Demand Forecast transactions to support the Web Services automation in the VicGas Wholesale market. Provides for the forecast submissions and retrieval functions. Relevant operation descriptions are provided in the section n.n	Enhancement
3.	Inclusion of new Injection Hedge Nomination transactions to support the Web Services automation in the VicGas Wholesale market. Provides for the injection hedge nominations submission and retrieval functions. Relevant operation descriptions are provided in the section n.n.	Enhancement
4.	Inclusion of new Agency Injection Hedge transactions to support the Web Services automation in the VicGas Wholesale market. Provides for the agency injection hedge nominations submission and retrieval functions. Relevant operation descriptions are provided in the section n.n.	Enhancement
5.	System transactions provide Market Participants for additional information regarding to the application state and attributes.	Enhancement

1.2 Web Services - Bid Service

The Bid Service is responsible for all bid-related functionality, including retrieving bid information, searching for bid information and submitting new bid information to the VENCORP gas market system. The UML representation of the operations exposed via this web services is shown in the following figure.

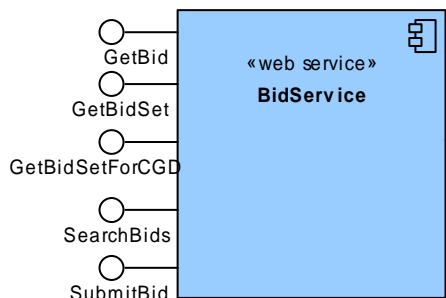

1.2.1 GetBid

The `getBid()` method obtains all the data for a particular bid based on its bid identifier in the VENCORP system (Bid ID), including the individual bid steps that comprise the bid stack.

Only bids submitted by the logged in user, or another user within the same company/organization, will be viewable using this method.

1.2.2 GetBidSet

The `getBidSet()` method obtains all the data for a particular bid set based on its bid set identifier in the VENCORP system (Bid Set ID). A bid set is a collection of bids which can span multiple days (a standing bid) or represent a single day's set of bids for one or more scheduling horizons.

1.2.3 GetBidSetForCGD

The `getBidSetForCGD()` method obtains all the data for the latest bid set for the current gas day. This is a convenience method as the same data can be obtained via the related `getBid()` or `searchBids()` calls.

1.3 SearchBids

The `searchBids()` method searches for bid information matching the criteria specified in the request message. The search can be based on:

- Start and end date
- MIRN
- Bid Type (Injection/Withdrawal)

The response message will contain zero or more matching bids.

1.4 SubmitBid

The `submitBid()` method submits bid information for processing by the VENCORP gas market system, using the supplied date range, bid type and price/quantity information. SOAP faults will be generated if the submission is not accepted due to missing the interval cutoff time and for other reasons. The possible SOAP faults are documented below along with the potential causes of the faults.

1.5 Web Services – Demand Forecast Service

The Demand Forecast Service is responsible for all demand forecast-related functionality, including retrieving forecast data and submitting new forecast information to the VENCORP gas market system.

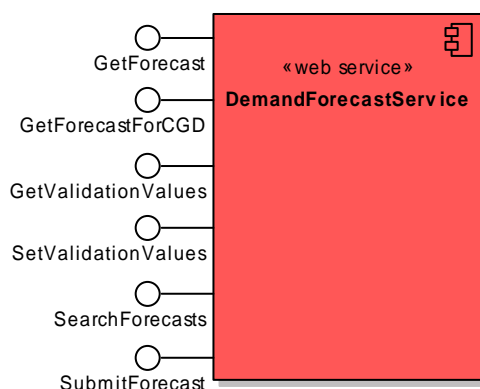

The service provides the following operations:

- GetForecast
- GetForecastForCGD
- GetValidationValues
- SetValidationValues
- SearchForecasts
- SubmitForecast

1.5.1 GetForecast

The `getForecast()` method obtains all the data for a particular demand forecast based on its demand forecast identifier in the VENCORP system (Demand Forecast ID), including the individual hourly values that comprise the forecast.

1.5.2 GetForecastForCGD

The `getForecastForCGD()` method obtains all the data for the latest demand forecast for the current gas day. This is a convenience method as the same data can be obtained via the related `getForecast()` or `searchForecasts()` calls.

1.5.3 GetValidationValues

The `getValidationValues()` method retrieves the demand forecast hourly validation values supplied by the participant during the initial VENCORP gas market registration process. These values provide an upper limit on the forecast values that can be entered by the participant for demand forecasts, either through the web front end or via SOAP.

1.5.4 SetValidationValues

The `setValidationValues()` method sets the demand forecast hourly validation values that are initially supplied by the participant during the VENCORP gas market registration process. These values provide an upper limit on the forecast values that can be entered by the participant for demand forecasts, either through the web front end or via SOAP.

1.5.5 SearchForecasts

The `searchForecasts()` method searches for demand forecast information matching the criteria specified in the request message. The search can be based on:

- Start and end date
- Site specificity
- MIRN (if site specific)

The response message will contain zero or more matching demand forecast records.

1.5.6 SubmitForecast

The `submitForecast()` method submits demand forecast information for processing by the VENCORP gas market system, using the supplied date range, MIRN (for site specific forecasts) and other information. SOAP faults will be generated if the submission is not accepted for whatever reason. The possible SOAP faults are documented below along with the potential causes of the faults.

1.6 Web Services – Injection Hedge Nomination Service

The Injection Hedge Nomination Service is responsible for all injection hedge nomination functionality, including retrieval of the historical data and submission of new injection hedge nominations to the VENCORP gas market system.

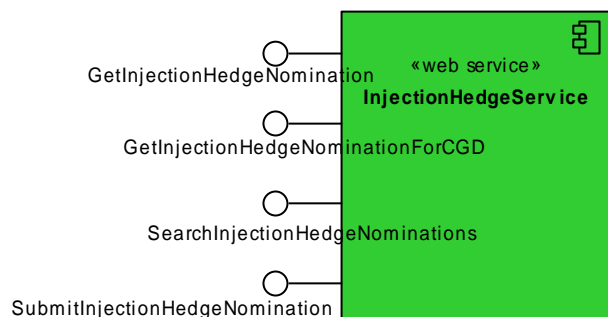

The service provides the following operations:

- `GetInjectionHedgeNomination`
- `GetInjectionHedgeNominationForCGD`
- `SearchInjectionHedgeNominations`
- `SubmitInjectionHedgeNomination`

1.6.1 `GetInjectionHedgeNomination`

The `getInjectionHedgeNomination()` method obtains all the data for a particular injection hedge nomination based on its identifier (Injection Nomination Header Id).

Note, the number of entries returned in AMIQS element of the response will be equal to the number of scheduling intervals in a gas day. If no AMIQ value was supplied during the submission, then zero will be stored.

1.6.2 `GetInjectionHedgeNominationForCGD`

The `getInjectionHedgeNominationForCGD()` method returns the injection hedge nomination that is effective for the current gas day.

1.6.3 `SearchInjectionHedgeNominations`

The `searchInjectionHedgeNominations()` operation is responsible for the retrieval of injection hedge nominations that fall into specified period. This operation will return data if:

- There is a nomination – either standing or for individual gas day, and
- The date range provided in the parameter is either completely enclosed in the above standing nomination, or
- Period's termination date is after than the nomination's commencement date, or
- Period's commencement date is before the nomination's termination date.

Only nominations submitted by the logged in user, or another user within the same company/organization, will be viewable using this method.

1.6.4 `SubmitInjectionHedgeNomination`

The `submitInjectionHedgeNomination()` operation submits injection hedge nomination information for processing by the VENCORP gas market system, using the supplied date range, MIRN and other information.

AMDQ and AMDQ Credit quantities supplied in the request must be of integer type, in GJ. AMIQ profile values are percentage. AMIQ profile values must be provided for every scheduling interval.

1.7 Web Services – Agency Hedge Nomination Service

The Agency Injection Hedge Nomination Service is responsible for all agency-related functionality. That includes all the functions available through the front-end browser interface, i.e. nomination of an agent, confirming nominations, withdrawal of nominations, and search for historical agency nominations.

Please note the usage of `AgencyNominationHeaderId` and `AgencyNominationId`:

- *AgencyNominationHeaderId* is an identifier for the entire group of nominations submitted at the same time. This corresponds to the Agency Nomination screen on the VENCORP gas market system's browser interface where up to 10 agency nominations can be made. The *AgencyNominationHeaderId* is returned to the user following the successful submission of the group of nominations.

- *AgencyNominationId* is an identifier of the individual agency nomination as it is being tracked by the VENCORP gas market. This identifier appears next to the individual agency nomination following the successful submission. It is the identifier that will be returned/displayed when searching for nominations.

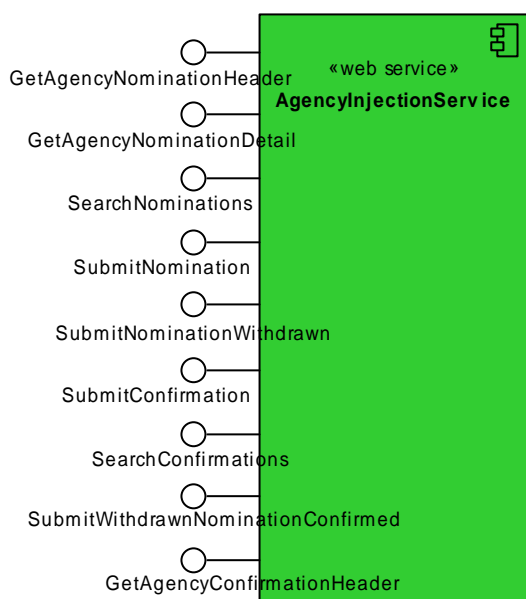

This service provides the following operations:

- GetAgencyNominationHeader
- GetAgencyNominationDetail
- SearchNominations
- SubmitNomination
- SubmitNominationWithdrawn
- SubmitConfirmation
- SearchConfirmations
- SubmitWithdrawnNominationConfirmed
- GetAgencyConfirmationHeader

1.7.1 GetAgencyNominationHeader

The `getAgencyNominationHeader()` operation is responsible for the retrieval of the set of agency nominations identified by the provided header identifier – *AgencyNominationHeaderId*.

1.7.2 GetAgencyNominationDetail

The `getAgencyNominationDetail()` operation is responsible for the retrieval of the individual nomination details as specified in the operation parameter.

1.7.3 SearchNominations

The `searchNominations()` operation is responsible for retrieval of the agency nominations that satisfy the search parameters.

The mandatory parameter <NMI> specifies the meter for which the search must be performed. The optional parameter <Period> defines the date range for which the agency nomination will be searched for. If not specified, then the current gas day will be assumed.

1.7.4 SubmitNomination

The `submitNomination()` operation will allow the user to submit the agency nomination to the VENCORP gas market system. The user will be able to submit nominations for meters registered to the company/organisation the user belongs to.

Upon successful submission, the VENCORP gas market system will generate notification emails (in accordance with the Participant Build Pack) to the nominated party, and the company/organisation who created the nomination.

1.7.5 SubmitNominationWithdrawn

The `submitNominationWithdrawn()` operation allows the user to withdraw the previously submitted agency nomination. It does not provide for the withdrawal of the entire nomination group (as identified by the header id), but rather the individual nomination (as identified by the nomination id).

An individual nomination can be withdrawn either before the confirmation for that nomination is submitted, or after the confirmation. In both cases notifications will be generated by VENCORP gas market system to the counterparties.

Upon successful submission, the status of the nomination will be set to "NWDN".

1.7.6 SubmitConfirmation

The `submitConfirmation()` operation is responsible for submission of a confirmation for the individual agency hedge nomination. This confirmation, upon successful submission, will change the status of the specified agency nomination to "NCON". The successful operation will trigger a notifications sent to both parties.

1.7.7 SearchConfirmations

The `searchConfirmation()` operation is responsible for searching the submitted agency nomination confirmations. The only confirmations submitted by the logged in user, or another user from the same company/organisation will be viewable from this operation.

1.7.8 SubmitWithdrawnNominationConfirmed

The `submitWithdrawnNominationConfirmed()` operation is responsible for submission of the confirmation for the the nomination that had been withdrawn. Only nominations made to the logged-in user, or another user from the same company/organisation will be updateable via this operation. The successful submission via this operation will change the status of the specified nomination to "WCON".

1.7.9 GetAgencyConfirmationHeader

The `getAgencyConfirmationHeader()` operation is responsible for retrieval of the agency nomination status - actually the complete nomination only without the agency nomination header identifier - as per specified individual agency nomination id. This operation shall be executed only by the nominee/agent.

1.8 Web Services – System Service

The System Service is responsible for all general purpose utility functions and functionality, which does not fall strictly into one of the other functional areas. Functionality provided includes the ability to get the current gas date and time from the VENCORP system, as well as information such as scheduling intervals and so on.

1.8.1 GetCurrentGasDate

The `GetCurrentGasDate()` method retrieves the current gas date from the VENCORP system.

1.9 Reason for Change

The requested change will facilitate the implementation of the Wholesale Gas Market by providing Market Participants with ability to integrate their trading processes with the VENCORP's Gas Market Systems via the web services / automation interfaces described in this change request.

The submission and retrieval of information is via XML fragments constructed in line with rules for specific to the wholesale gas market transactions as would be defined in aseXML. The submissions are supported by web services' document style and literal use.

This change request also ensures that the consistency is maintained in the implementation of information exchange systems for Market Participants with the use of XML in the FRC area.

1.10 Baseline Schema

The aseXML_r19 schema used as a basis for this proposal.

2 Approval Proposal

2.1 Draft Schema

Draft schema created as aseXML_r20.xsd

2.2 Change log

The following changes have been implemented in this draft:

Chg #	Item #	Description of change	File
1	All	Abstract definition of eight new generic wholesale transactions	New file MarketWholesale_r20.xsd
2	All	Addition of payloads of each of the transactions	New file GasMarketWholesale_r20.xsd
3	All	Addition of new event for R20	Event_r20.xsd
4	All	Addition of eight new wholesale transactions	Transactions_r20
5	All	Addition of new transaction Group MKTW - Wholesale market operations	Header_r20
6	All	Use of default versioning for new transactions and derived types.	MarketWholesale_r20.xsd & GasMarketWholesale_r20.xsd
7	All	Namespace changed to include r20 version attribute; r20 files included	aseXML_r20

Table 2-1 Change Log

2.3 Schema change description

The impact of changes required by this document is fairly minimal:

- An update to the top level schema to import additional wholesale schemas.
- Update of the Events schema to add an identifier for the release “r20”.
- Update of the top level schema version to r20.
- An introduction of the wholesale market schema component.
- An introduction of the wholesale gas market schema component.
- Introduction of eight new Transactions
- Use of default versioning for transaction and type defined

The impact of this change request is reduced by the fact that only limited number of the existing types is used by the gas wholesale market schema: NMI and Period. Also, none of the transactions being defined within this change request are currently anticipated to be part of FRC B2B exchange. It is noted that the Guidelines indicate the use of Mandatory versioning at the Transaction Level. It is believed that the use of Default versioning with the introduction of new transactions is appropriate and will provide the benefit of minimising the amount of change needed to be performed with updates to the schema.

2.3.1 aseXML Top Level Schema

The changed portions of the schema are highlighted using bold font and additional items have a surrounding border.

```
<xsd:include schemaLocation="Events_r20.xsd">
  <xsd:annotation>
    <xsd:documentation>- Include data types for status reporting
    </xsd:documentation>
  </xsd:annotation>
</xsd:include>

<xsd:include schemaLocation="Header_r20.xsd">
  <xsd:annotation>
    <xsd:documentation>- Include data types for aseXML message headers
    </xsd:documentation>
  </xsd:annotation>
</xsd:include>
```

```
<xsd:include schemaLocation="MarketWholesale_r20.xsd">
  <xsd:annotation>
    <xsd:documentation>- Include data types for common market wholesale functionality.
    </xsd:documentation>
  </xsd:annotation>
</xsd:include>

<xsd:include schemaLocation="GasMarketWholesale_r20.xsd">
  <xsd:annotation>
    <xsd:documentation>- Include data types for gas market wholesale functionality.
    </xsd:documentation>
  </xsd:annotation>
</xsd:include>
```

```
<xsd:include schemaLocation="Transactions_r20.xsd">
  <xsd:annotation>
    <xsd:documentation>- Include data types for carrying transactions within aseXML
    </xsd:documentation>
  </xsd:annotation>
</xsd:include>
```

2.3.2 Transactions schema

The schema introduces the following eight new transactions:

```
WholesaleRetrieveRequest
WholesaleRetrieveResponse
WholesaleSearchRequest
WholesaleSearchResponse
WholesaleSubmitRequest
WholesaleSubmitResponse
WholesaleInformationRequest
WholesaleInformationResponse
```

2.3.3 Events schema

This schema file will have release number incremented to **r20**. Also, "r20" identifier will be appended into this schema.

```
<xsd:simpleType name="r20">
  <xsd:annotation>
    <xsd:documentation>Purpose - Release r20 identifier</xsd:documentation>
  </xsd:annotation>
  <xsd:restriction base="ReleaseIdentifier">
    <xsd:enumeration value="r20"/>
  </xsd:restriction>
</xsd:simpleType>
```

2.3.4 Header schema

This schema file will have release number incremented to **r20**. The file is to be modified for the inclusion of the new Transaction Group for the Wholesale Market:

```
<xsd:simpleType name="TransactionGroup">
  <xsd:simpleType name="TransactionGroup">
    <xsd:annotation>
      <xsd:documentation>
        MKTW - Wholesale market operations
      </xsd:documentation>
    </xsd:annotation>
    <xsd:restriction base="xsd:string">
      <xsd:enumeration value="MKTW"/>
    </xsd:restriction>
  </xsd:simpleType>
```

2.3.5 Market Wholesale Schema

This schema introduces base types common to both gas and electricity wholesale markets.

```
<?xml version="1.0" encoding="UTF-8"?>
<xsd:schema xmlns:xsd="http://www.w3.org/2001/XMLSchema">
  <!-- ===== -->
  <!-- Transaction Definitions -->
  <!-- ===== -->
  <xsd:complexType name="WholesaleRetrieveRequest">
    <xsd:sequence>
      <xsd:element name="RetrieveRequestData" type="WholesaleRetrieveRequestData"/>
    </xsd:sequence>
    <xsd:attribute name="version" type="r20" use="optional" default="r20"/>
  </xsd:complexType>
```



```

<xsd:complexType name="WholesaleRetrieveResponse">
  <xsd:sequence>
    <xsd:element name="RetrieveResponseData" type="WholesaleRetrieveResponseData"/>
  </xsd:sequence>
  <xsd:attribute name="version" type="r20" use="optional" default="r20"/>
</xsd:complexType>
<xsd:complexType name="WholesaleSearchRequest">
  <xsd:sequence>
    <xsd:element name="SearchRequestData" type="WholesaleSearchRequestData"/>
  </xsd:sequence>
  <xsd:attribute name="version" type="r20" use="optional" default="r20"/>
</xsd:complexType>
<xsd:complexType name="WholesaleSearchResponse">
  <xsd:sequence>
    <xsd:element name="SearchResponseData" type="WholesaleSearchResponseData"/>
  </xsd:sequence>
  <xsd:attribute name="version" type="r20" use="optional" default="r20"/>
</xsd:complexType>
<xsd:complexType name="WholesaleSubmitRequest">
  <xsd:sequence>
    <xsd:element name="SubmitRequestData" type="WholesaleSubmitRequestData"/>
  </xsd:sequence>
  <xsd:attribute name="version" type="r20" use="optional" default="r20"/>
</xsd:complexType>
<xsd:complexType name="WholesaleSubmitResponse">
  <xsd:sequence>
    <xsd:element name="SubmitResponseData" type="WholesaleSubmitResponseData"/>
  </xsd:sequence>
  <xsd:attribute name="version" type="r20" use="optional" default="r20"/>
</xsd:complexType>
<xsd:complexType name="WholesaleInformationRequest">
  <xsd:sequence>
    <xsd:element name="InformationRequestData" type="WholesaleInformationRequestData"/>
  </xsd:sequence>
  <xsd:attribute name="version" type="r20" use="optional" default="r20"/>
</xsd:complexType>
<xsd:complexType name="WholesaleInformationResponse">
  <xsd:sequence>
    <xsd:element name="InformationResponseData" type="WholesaleInformationResponseData"/>
  </xsd:sequence>
  <xsd:attribute name="version" type="r20" use="optional" default="r20"/>
</xsd:complexType>
<!-- ===== -->
<!-- Transaction Payload Definitions -->
<!-- ===== -->
<xsd:complexType name="WholesaleRetrieveRequestData" abstract="true"/>
<xsd:complexType name="WholesaleRetrieveResponseData" abstract="true"/>
<xsd:complexType name="WholesaleSearchRequestData" abstract="true"/>
<xsd:complexType name="WholesaleSearchResponseData" abstract="true"/>
<xsd:complexType name="WholesaleSubmitRequestData" abstract="true"/>
<xsd:complexType name="WholesaleSubmitResponseData" abstract="true"/>
<xsd:complexType name="WholesaleInformationRequestData" abstract="true"/>
<xsd:complexType name="WholesaleInformationResponseData" abstract="true"/>
</xsd:schema>

```

2.3.6 Gas Market Wholesale Schema

Addition of the following Complex Types, which are extension of their corresponding Wholesale Complex base types, shown using UML class notation, as defined in 2.3.5.

2.3.6.1 GasRetrieveRequestData

GasRetrieveRequestData is an extension of the WholesaleRetrieveRequestData complex element.

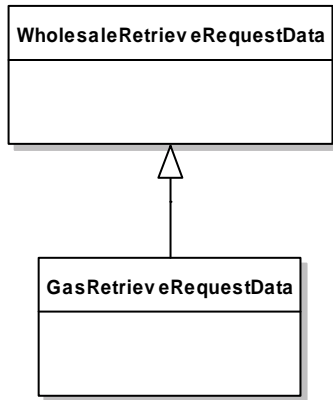

Below is a representation of the GasRetrieveRequestData complex element as required by gas wholesale market.

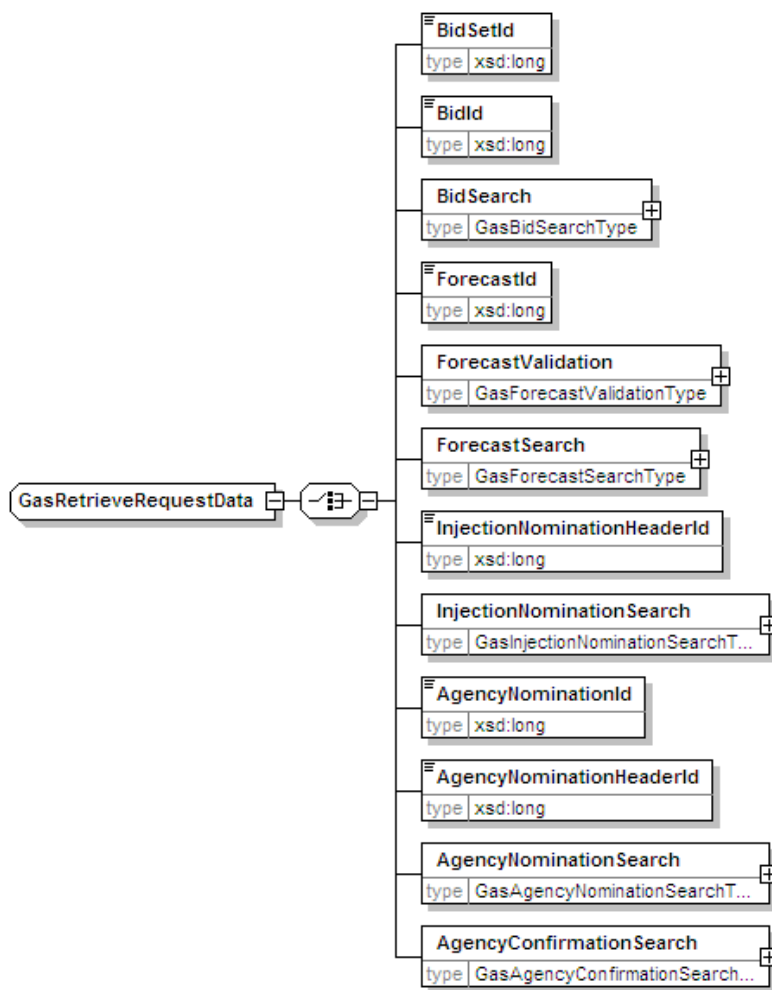

2.3.6.2 GasRetrieveResponseData

GasRetrieveResponseData is an extension of the WholesaleRetrieveResponseData complex element. It will be sent in response to GasRetrieveRequestData element.

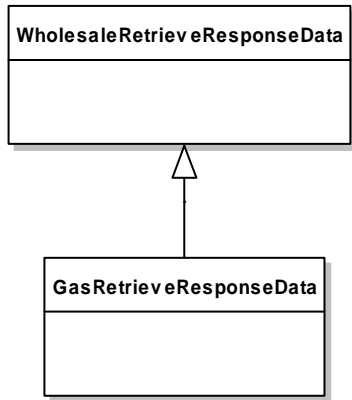

The following is a representation of the GasRetrieveResponseData element as required by the gas wholesale market.

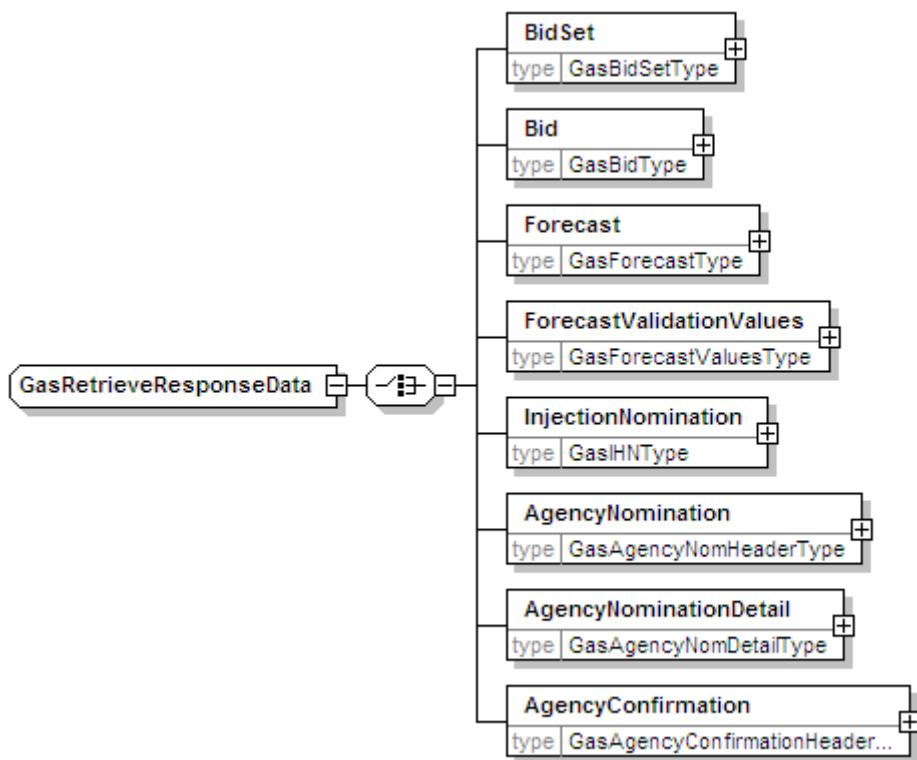

2.3.6.3 GasSearchRequestData

GasSearchRequestData is an extension of the WholesaleSearchRequestData complex element.

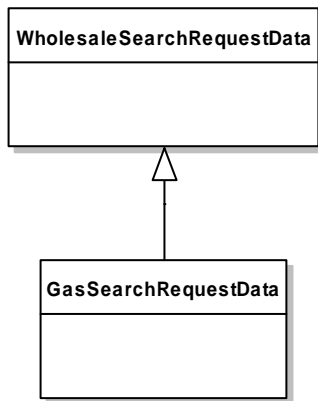

The following is a representation of the GasSearchRequestData element as required by the gas wholesale market.

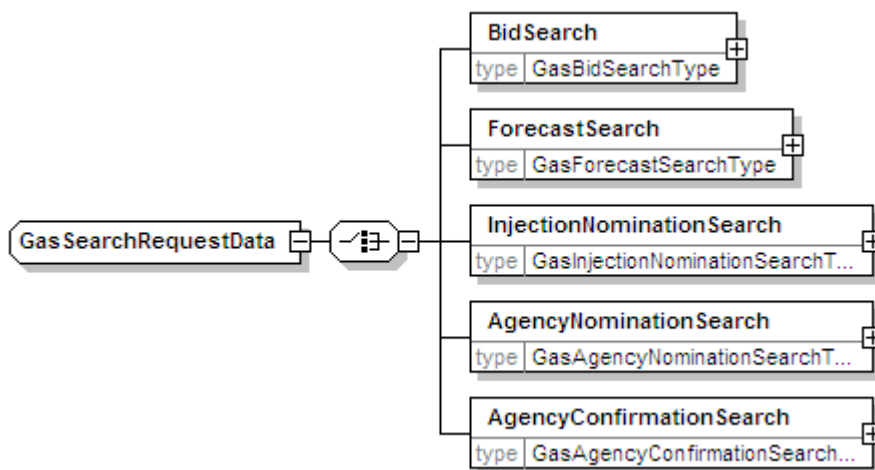

2.3.6.4 GasSearchResponseData

The GasSearchResponseData is an extension of the WholesaleSearchResponseData complex element. It will be generated in response to the web service request containing GasSearchRequestData complex element.

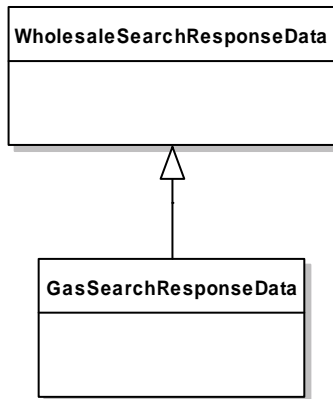

The following is a representation of the GasSearchResponseData complex element as required by wholesale gas market.

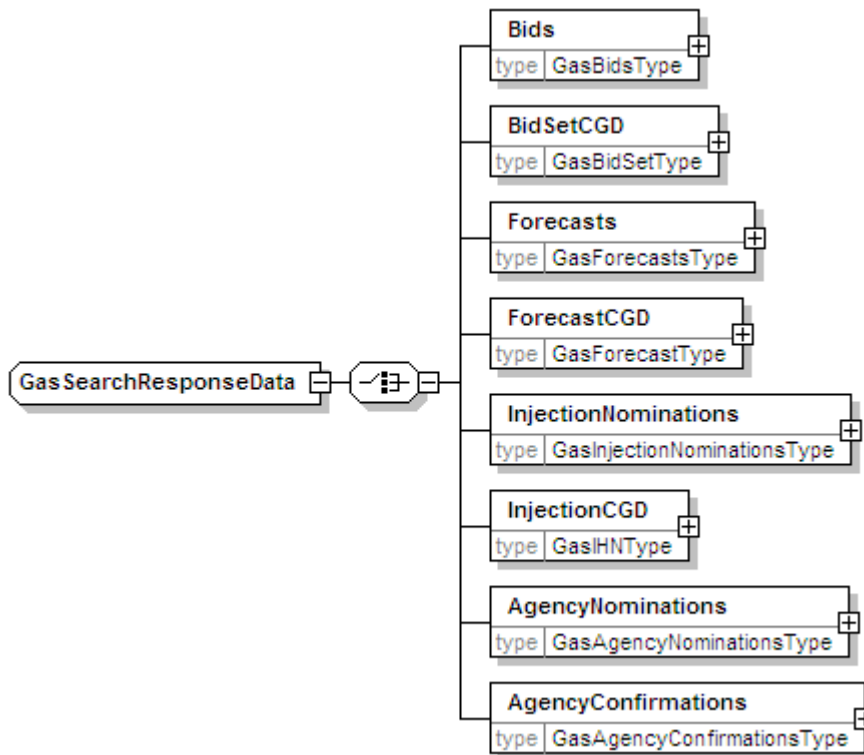

2.3.6.5 GasSubmitRequestData

The GasSubmitRequestData is a complex type extending the WholesaleSubmitRequestData complex element.

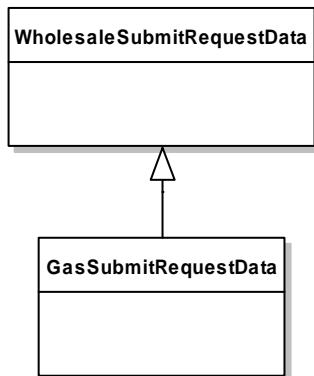

The following is a representation of the GasSubmitRequestData complex element as required by the wholesale gas market.

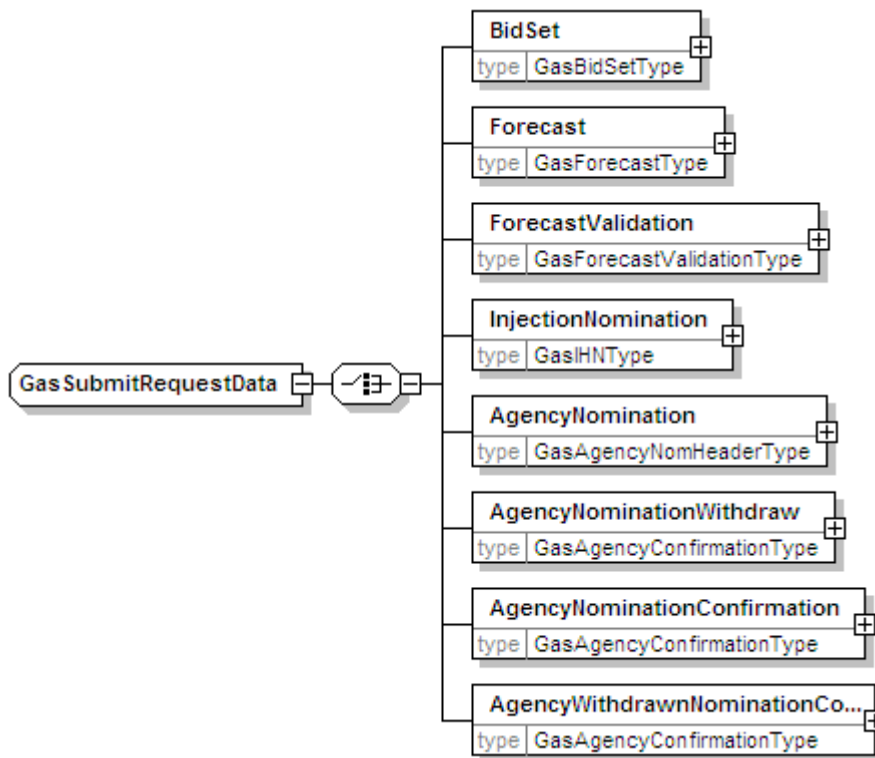

2.3.6.6 GasSubmitResponseData

The GasSubmitResponseData complex type is an extension of the WholesaleSubmitResponseData complex type. It will be generated in response to GasSubmitRequestData element.

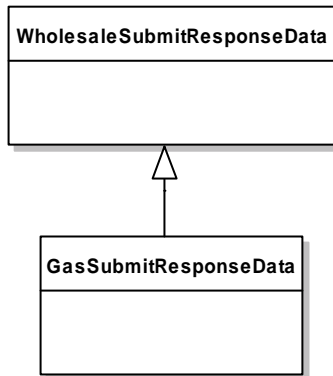

The following is a representation of the GasSubmitResponseData complex type as required by wholesale gas market.

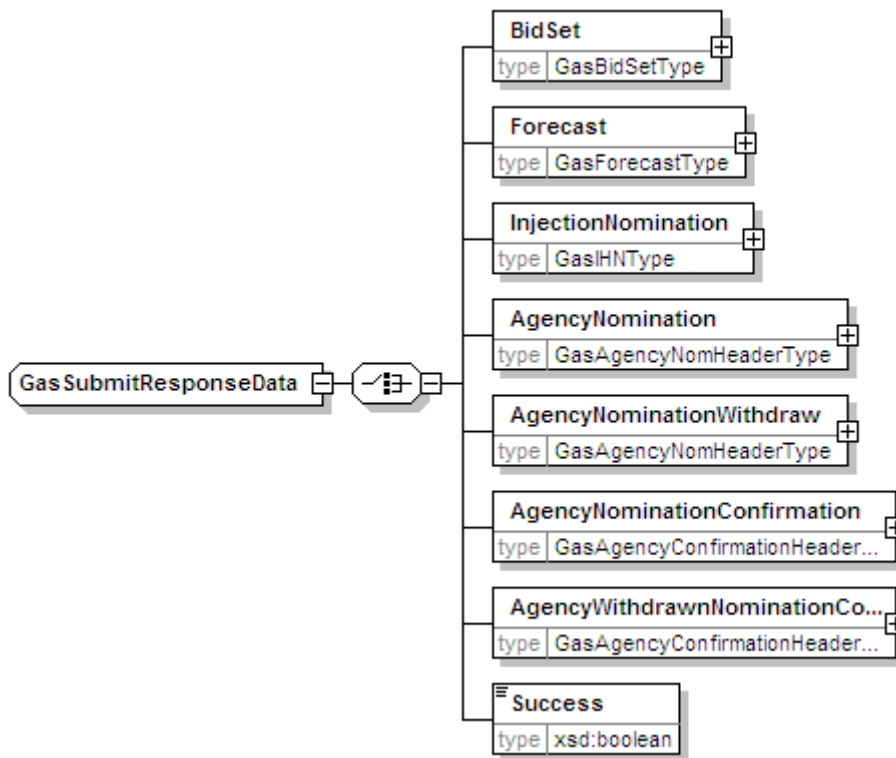

2.3.6.7 GasInformationRequestData

The GasInformationRequestData is an extension of the WholesaleInformationRequestData complex type.

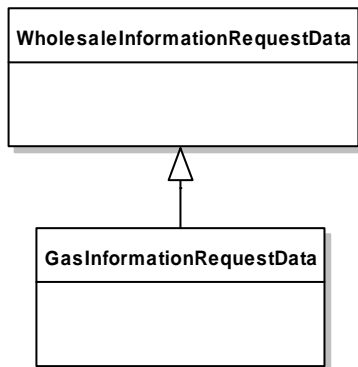

The following is a representation of the GasInformationRequestData as required by whole gas market.

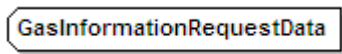

2.3.6.8 GasInformationResponseData

The GasInformationResponseData is an extension of the WholesaleInformationResponseData complex type. It will be generated in response to GasInformationRequestData.

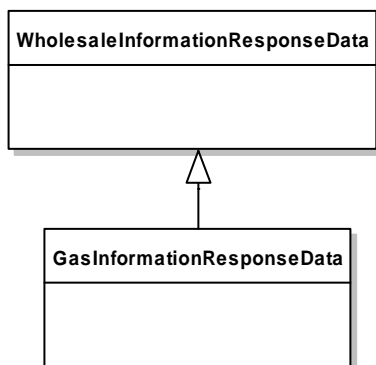

The following is a representation of the GasInformationResponseData complex type as required by wholesale gas market.

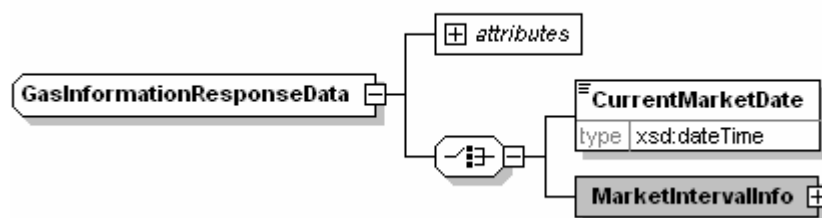

2.4 Impact Summary

This table identifies the files, transactions and versioned types that are potentially impacted as the result of these changes where:

- o Modified types - is a full list of types changed by this Change Request
- o Derived types – is a list of any types that are derived from a modified type, and are therefore also modified by default
- o Versioned types affected – is a list of all versioned types that will need to have the version attribute updated as a result of this Change Request
- o Transactions potentially affected – is a list of all transactions that contain a modified type, either directly or via a type substitution
- o Schema files affected – is a list of schema files that will be changed in some way as a result of this Change Request.

Modified types	Derived types	Versioned types affected	Transactions potentially affected	Schema files affected
Transaction	-	-	-	Transactions_r20.xsd
TransactionGroup	-	-	-	Header_r20.xsd
New types for additional Gas Wholesale transactions	-	-	-	New: MarketWholesale_r20.xsd GasMarketWholesale_r20.xsd

Table 2-2, Impact Summary

2.5 Developer Test

2.5.1 Test Platforms

The new schema has been tested using the following platforms as advised by ASWG:

- XMLSpy 2006
- MSXML4 SP1
- Xerces 1.4.4 and 2.2.1

2.5.2 Test Cases

<List any sample files provided>

3 Proposal Assessment

3.1 Test

The ASWG ensures that all recommended parsers on relevant platforms can successfully validate the proposed schema.

3.1.1 Test Platforms

Supplied samples have been tested using the following parsers:

- MSXML 4.0 SP1
- Xerces 2.2.1
- XMLSpy 2006

3.1.2 Test Cases

GasInformationRequestData_CGD.xml
GasInformationRequestData_ID.xml
GasInformationResponseData_CGD.xml
GasInformationResponseData_ID_1.xml
GasInformationResponseData_ID_2.xml
GasRetrieveRequestData_AgencyConfirmationHeader.xml
GasRetrieveRequestData_AgencyNominationDetail.xml
GasRetrieveRequestData_AgencyNominationHeader.xml
GasRetrieveRequestData_BidSetCGD.xml
GasRetrieveRequestData_ForecastCGD.xml
GasRetrieveRequestData_ForecastId.xml
GasRetrieveRequestData_ForecastValidation.xml
GasRetrieveRequestData_GasForecastValidationType.xml
GasRetrieveRequestData_GetBid.xml
GasRetrieveRequestData_GetBidSet.xml
GasRetrieveRequestData_InjectionNomination.xml
GasRetrieveRequestData_InjectionNominationCGD.xml
GasRetrieveResponseData_AgencyConfirmationHeader.xml
GasRetrieveResponseData_AgencyNominationDetail.xml
GasRetrieveResponseData_AgencyNominationHeader.xml
GasRetrieveResponseData_BidSetCGD.xml
GasRetrieveResponseData_ForecastCGD.xml
GasRetrieveResponseData_ForecastId.xml
GasRetrieveResponseData_ForecastValidation.xml
GasRetrieveResponseData_GasForecastValidationType.xml

GasRetrieveResponseData_GetBid.xml
 GasRetrieveResponseData_GetBidSet.xml
 GasRetrieveResponseData_InjectionNomination.xml
 GasRetrieveResponseData_InjectionNominationCGD.xml
 GasSearchRequestData.xml
 GasSearchRequestData_AgencyConfirmation.xml
 GasSearchRequestData_AgencyNomination.xml
 GasSearchRequestData_forecast.xml
 GasSearchRequestData_InjectionNomination.xml
 GasSearchResponseData.xml
 GasSearchResponseData_AgencyConfirmation.xml
 GasSearchResponseData_AgencyNomination.xml
 GasSearchResponseData_forecast.xml
 GasSearchResponseData_InjectionNomination.xml
 GasSubmitRequestData_AgencyNomination.xml
 GasSubmitRequestData_AgencyNominationConfirmation.xml
 GasSubmitRequestData_AgencyNominationWithdraw.xml
 GasSubmitRequestData_AgencyWithdrawnNominationConfirmed.xml
 GasSubmitRequestData_Bid.xml
 GasSubmitRequestData_Forecast.xml
 GasSubmitRequestData_InjectionNomination.xml
 GasSubmitResponseData_AgencyNomination.xml
 GasSubmitResponseData_AgencyNominationConfirmation.xml
 GasSubmitResponseData_AgencyNominationWithdraw.xml
 GasSubmitResponseData_AgencyWithdrawnNominationConfirmed.xml
 GasSubmitResponseData_Bid.xml
 GasSubmitResponseData_Forecast.xml
 GasSubmitResponseData_InjectionNomination.xml

The above xml sample docs have been validated using the above parsers.

3.1.3 Test Results

The XML sample files were successfully validated.

3.2 Conformance Report

The ASWG completes the conformance report validating each proposed new schema file against the published aseXML guidelines.

Schema Filename	Impacted by Item #	Conformance Details
aseXML_r20.xsd	All	Conforms

Schema Filename	Impacted by Item #	Conformance Details
Event_r20.xsd	All	Conforms
Header_r20.xsd	All	Conforms
Transactions_r20.xsd	All	Conforms
MarketWholesale_r20.xsd	All	Conforms
GasMarketWholesale_r20.xsd	All	Conforms

Table 3-1, Change Proposal Conformance Details

4 Issue Register

This section describes any issues that have arisen and any modifications that are made to the original proposal during the Change Process

4.1 Status of Issues

Issue#	Description and Discussion	Status	Resolution
1	Forecast value needs ability to indicate time	Done	Addition of new attribute on forecast value to indicate time
2	GasInformationResponse needs ability to provide Market Information	Done	Addition of MarketIntervalInfo type to GasInformationResponseData
3	LastModified element could contain empty string	Done	Addition of minLength restrictions on LastModifiedBy element
4	xsi:nil = false is explicitly applied to some instances of NMI element. 'false' is default and should not be explicitly defined	Done	Removal of xsi:nil attribute for NMI
5	<p>The proposal to add 'default' capability to transaction version attributes has not yet been agreed by the ASWG. As such it is not included in current draft releases. The issue will be considered at the ASWG meeting on 1st September, the outcome of which may entail an update to the draft schema. All ASWG Subscribers and Users are encouraged to consider the proposal and provide input to the discussion through their ASWG member.</p> <p>The use of 'default' capability on derived Gas Types in these transactions has been approved.</p>	Done	Following discussion on 1 Sep the ASWG has agreed to apply default version attributes to these new transactions, as well as the gas derived types in this instance. Whether this will be applied across the board for future new transactions is still undecided.

Table 4-1, Issues list

5 Resolution

The ASWG votes for endorsement of the options identified in section 2, and the voting results are forwarded to NEMMCO for approval. When 75% of those ASWG members who voted endorse a specific option, this represents an ASWG Recommendation for that option. NEMMCO will not reject an ASWG Recommendation without first consulting with the ASWG.

5.1 Draft Schema ASWG Vote

The results of the ASWG vote for the draft schema to be released are as follows:

Date of Vote: 18/8/2006

Option	# Votes	% Vote
Option 1 (section 2.1) (see note below)	6	86%
Abstained ¹	1	14%
Total Members Present	7	100%

Table 5-1, ASWG Vote Results for Draft Schema

Note: There is one unresolved issue that was excluded from the vote. See section 4 for details

5.2 Default Transaction Versions ASWG Vote

The results of the ASWG vote for the introduction of default version attributes at transaction level for these new transactions is as follows (unresolved issue from above):

Date of Vote: 1/9/2006

Option	# Votes	% Vote
Option 1 (section 2.1) (see note below)	6	100%
Abstained		
Total Members Present	6	100%

Table 5-2, ASWG Vote Results for Default Transaction Versions

¹ Member abstained due to limited knowledge of aseXML at this point in time

5.3 Final Schema ASWG Vote

The results of the ASWG vote for the final schema to be released are as follows:

Date of Vote: 15/9/2006

Option	# Votes	% Vote
Option 1 (section 2.1)	5	83%
Abstained ²	1	17%
Total Members Present	6	100%

Table 5-3, ASWG Vote Results for Final Schema

² Member abstained due to limited knowledge of aseXML at this point in time